

# Simulation of valve gear dynamics using generalized dynamic model

**A. Vasilyev**

Volgograd State Technical University, Lenin Avenue 28, 400131 Volgograd, Russia, E-mail: vasilyev@vstu.ru

## 1. Introduction

Valve gear dynamics investigation of internal combustion engines is carried out with the purpose of determination of operating forces, strains of links and real laws of details motion. On its basis the lack of kinematic chain breaks during valve motion is determined, and the calculations of details strength is carried out.

The calculation of valve gear dynamics usually is carried out by its representation as localized masses, connected with each other by elastic elements, to solve a system of the differential equations, describing oscillatory processes [1, 2]. The features of masses quantity variation should be allowed to provide adequate representation of valve gear elements in the model, for example, valve springs. It is necessary to note, that different kinematic valve gear schemes are applied in the internal combustion engines, such as with the upper and lower disposition of the camshaft, with a drive for several valves from one cam, with one or several valve springs, with spring-backed pushrod. In this connection it is important to develop generalized mathematical model without limitations on its structure and quantity of masses, where the particular calculation scheme is created in an automated procedure.

## 2. Mathematical model

The differential equations of  $N$  concentrated masses system is

$$m_i \ddot{x}_i = P_i - F_i + \sum_{n=1}^{n_i} (P_{in} - F_{in}) \quad (i = 1, \dots, N) \quad (1)$$

where  $m_i$  is mass with number  $i$ ;  $\ddot{x}_i$  is its acceleration;  $P_i$  is external force, acting on  $i$ th number mass (for example, force from cylinder gas pressure);  $F_i$  is external friction force;  $n_i$  is number of mass  $m_i$  connections with other masses or with rigid support;  $P_{in}$  and  $F_{in}$  are forces accordingly from resilience and from internal friction in  $n$ th link, acting on  $i$ th mass.

External force  $P_i$  is determined as the sum of stationary component  $(P_i)_{const}$ , not varying during all cycle, and variable component  $(P_i)_{var}$

$$P_i = (P_i)_{const} + (P_i)_{var} \quad (2)$$

Viscous friction force

$$F_i = b_i \dot{x}_i \quad (3)$$

where  $b_i$  is external friction factor;  $\dot{x}_i$  is velocity of  $i$ th mass.

For a two-way link, transmitting tensile and compressive forces

$$P_{in} = \mp (P_{in})_0 - c_{in} (x_i - x_j / r_{in} \pm s_{in}) \quad (4)$$

where  $(P_{in})_0$  is initial force (when  $x_i = x_j = 0$ );  $c_{in}$  is link stiffness;  $x_i$  and  $x_j$  are displacements of  $i$ th and  $j$ th accordingly,  $j$  is number of the mass, corresponding with link number  $n$ ;  $r_{in}$  is transference ratio (non equal to 1 for rocker arm);  $s_{in}$  is kinematic disturbance, which is dependent on the law of tappet motion for a cam - tappet link. In other cases this value is equal to zero.

In the Eq. (4) and further the upper sign corresponds to a case, when the mass  $j$  is located with deviation concerning mass  $i$  in positive direction of an axis  $OX$ , and lower sign - opposite case.  $(P_{in})_0$  is positive for compressed and negative for stretched link.

Transference ratio  $r_{in} = dx_j/dx_i$ , where  $x_i$  and  $x_j$  is increments of coordinates of the connected masses  $i$  and  $j$  provided that elastic link between them is not deformed in addition during system movement.

In one-way link, transmitting only compressing forces, current clearance  $\delta_{in}$  is calculated by the equation

$$\delta_{in} = \max \left\{ \left[ \Delta_{in} - s_{in} \mp (x_i - x_j / r_{in}) - (P_{in})_0 / c_{in} \right], 0 \right\} \quad (5)$$

where  $\Delta_{in}$  is initial clearance (when  $x_i = x_j = 0$ ).

Resilience force

$$P_{in} = \mp (P_{in})_0 - c_{in} \left[ x_i - x_j / r_{in} \pm (s_{in} - \Delta_{in}) \right] \quad (6)$$

for case  $\delta_{in} = 0$ . And  $P_{in}$  equal to zero if  $\delta_{in} \neq 0$ .

Internal friction force in the link is accepted to be proportional to the link deformation velocity. For a two-way link

$$F_{in} = b_{in} (\dot{x}_i - \dot{x}_j / r_{in} \pm \dot{s}_{in}) \quad (7)$$

where  $b_{in}$  is internal friction factor;  $\dot{x}_j$  is velocity of the  $j$ th mass;  $\dot{s}_{in}$  is kinematic disturbance velocity. Equation (7) for one-way link is valid under condition  $\delta_{in} = 0$ . Otherwise  $F_{in} = 0$ . The system of differential Eq. (1) is solved by numerical Runge-Kutta method.

The given generalized mathematical model of valve gear dynamics allows to build the calculation schemes of required structure and complexity according to valve gear type in an automated procedure, taking into consideration the valve gear design features, such as presence of initial forces or clearances in links, variability of

parameters, energy losses at oscillations, possibility of kinematic chain breaks in one-way links and impact interaction of details.

The presented generalized model was used for the investigation of various types valve gear dynamics, in particular, with the lower camshaft arrangement, with four-valve gear, etc. For example, the cam system dynamic model shown in Fig. 1 consists of nine masses. There are two-way links between elements 5 and 7, 6 and 8, 4 and 9, 1 and rigid support. Otherwise the links are one-way. Initial forces in valve springs  $(P_{4,5})_0 = (P_{5,7})_0 = (P_{7,0})_0 = (P_{sp1})_0$ ,

$(P_{4,6})_0 = (P_{6,8})_0 = (P_{8,0})_0 = (P_{sp2})_0$ . For the system in initial position take in balance, the following equality should be satisfied

$$(P_{4,9})_0 = -(P_{sp1})_0 + (P_{sp2})_0 \quad (8)$$

$$(P_{9,0})_0 = -(P_{4,9})_0 \quad (9)$$

where  $(P_{4,9})_0$  is initial tensile force in the valve stem;  $(P_{9,0})_0$  is the compressing force perceived by the valve seat. The system of differential Eq. (1) for dynamic model shown in Fig. 1 looks like

$$\left. \begin{aligned} m_1 \ddot{x}_1 &= -b_1 \dot{x}_1 - \left\{ c_{1,2} (x_1 - x_2 + s_{1,2}) + b_{1,2} (\dot{x}_1 - \dot{x}_2 + \dot{s}_{1,2}) \right\} - c_{1,0} x_1 - b_{1,0} \dot{x}_1 \\ m_2 \ddot{x}_2 &= -b_2 \dot{x}_2 - \left\{ c_{2,1} (x_2 - x_1 - s_{1,2}) + b_{2,1} (\dot{x}_2 - \dot{x}_1 - \dot{s}_{1,2}) \right\} - \left\{ c_{2,3} (x_2 - x_3 - \Delta_{2,3}) + b_{2,3} (\dot{x}_2 - \dot{x}_3) \right\} \\ m_3 \ddot{x}_3 &= -b_3 \dot{x}_3 - \left\{ c_{3,2} (x_3 - x_2 + \Delta_{3,2}) + b_{3,2} (\dot{x}_3 - \dot{x}_2) \right\} - \left\{ c_{3,4} \left( x_3 - \frac{x_4}{r_{3,4}} \right) + b_{3,4} \left( \dot{x}_3 - \frac{\dot{x}_4}{r_{3,4}} \right) \right\} \\ m_4 \ddot{x}_4 &= -b_4 \dot{x}_4 - \left\{ c_{4,3} \left( x_4 - \frac{x_3}{r_{4,3}} \right) + b_{4,3} \left( \dot{x}_4 - \frac{\dot{x}_3}{r_{4,3}} \right) \right\} - \left\{ (P_{4,5})_0 + c_{4,5} (x_4 - x_5) + b_{4,5} (\dot{x}_4 - \dot{x}_5) \right\} - \\ &- \left\{ [(P_{4,6})_0 + c_{4,6} (x_4 - x_6)] + b_{4,6} (\dot{x}_4 - \dot{x}_6) \right\} - [(P_{4,9})_0 + c_{4,9} (x_4 - x_9)] - b_{4,9} (\dot{x}_4 - \dot{x}_9) \\ m_5 \ddot{x}_5 &= -b_5 \dot{x}_5 + \left\{ [(P_{5,4})_0 - c_{5,4} (x_5 - x_4)] - b_{5,4} (\dot{x}_5 - \dot{x}_4) \right\} - [(P_{5,7})_0 + c_{5,7} (x_5 - x_7)] - b_{5,7} (\dot{x}_5 - \dot{x}_7) \\ m_6 \ddot{x}_6 &= -b_6 \dot{x}_6 + \left\{ [(P_{6,4})_0 - c_{6,4} (x_6 - x_4)] - b_{6,4} (\dot{x}_6 - \dot{x}_4) \right\} - [(P_{6,8})_0 + c_{6,8} (x_6 - x_8)] - b_{6,8} (\dot{x}_6 - \dot{x}_8) \\ m_7 \ddot{x}_7 &= -b_7 \dot{x}_7 + [(P_{7,5})_0 - c_{7,5} (x_7 - x_5)] - b_{7,5} (\dot{x}_7 - \dot{x}_5) - \left\{ [(P_{7,0})_0 + c_{7,0} x_7] + b_{7,0} \dot{x}_7 \right\} \left\{ [(P_{7,0})_0 + c_{7,0} x_7] + b_{7,0} \dot{x}_7 \right\} \\ m_8 \ddot{x}_8 &= -b_8 \dot{x}_8 + [(P_{8,6})_0 - c_{8,6} (x_8 - x_6)] - b_{8,6} (\dot{x}_8 - \dot{x}_6) - \left\{ [(P_{8,0})_0 + c_{8,0} x_8] + b_{8,0} \dot{x}_8 \right\} \\ m_9 \ddot{x}_9 &= -b_9 \dot{x}_9 + [(P_{9,4})_0 - c_{9,4} (x_9 - x_4)] - b_{9,4} (\dot{x}_9 - \dot{x}_4) + \left\{ [(P_{9,0})_0 - c_{9,0} x_9] - b_{9,0} \dot{x}_9 \right\} \end{aligned} \right\} \quad (10)$$

The value of  $r_{34}$  is equal to transference ratio of the rocker arm. Obviously,  $r_{34} = 1/r_{43}$ . For connections of other elements  $r_{ij} = 1$ . Obviously

$$c_{ji} = c_{ij}/(r_{ij})^2 \quad (11)$$

$$b_{ji} = b_{ij}/(r_{ij})^2 \quad (12)$$

The value of a current clearance in one-way links is calculated under the Eq. (5). The values of the resilience force and internal friction forces (enclosed in braces in Eq. (10)) are equated to zero if the link clearance is not equal to zero. Obviously

$$\Delta_{ji} = \Delta_{ij} r_{ij} \quad (13)$$

$$\delta_{ji} = \delta_{ij} r_{ij} \quad (14)$$

The simulation in a generalized aspect of lubrication hydrodynamics in clearances, hydraulic tappets, and also calculation of integrated characteristics for an estimation of model adequacy and valve gear dynamics are provided also.

Let us consider a case of oil film displacement from the gap. For the case of pure displacement for the determination of link resilience force instead of Eq. (6) it is necessary to use the following equation

$$P_{in} = \mp (P_{in})_0 - c_{in} \left[ x_i - x_j / r_{in} \pm (s_{in} + \delta_{in} - \Delta_{in}) \right] \quad (15)$$

Where the speed of change  $\dot{\delta}_{in}$  of the current gap filled with oil at the compressed link is determined by the formula

$$\dot{\delta}_{in} = -|P_{in} - F_{in}| \delta_{in}^3 / K_{in} \quad (16)$$

where  $K_{in}$  is coefficient, depending on the form and the sizes of contact.

If the corresponding one-way link, which is not transmitting tensile forces, is not compressed (that is  $(P_{in} - F_{in})$  accepts zero value), we believe, that the value  $\delta_{in}$  can increase in a case of mutual separation of masses

$$\dot{\delta}_{in} = \max \left\{ \left[ -\dot{s}_{in} \mp (\dot{x}_i - \dot{x}_j / r_{in}) \right], 0 \right\} \quad (17)$$

Accordingly, internal friction force in the link filled with oil is calculated by the formula

$$F_{in} = b_{in} \left[ \dot{x}_i - \dot{x}_j / r_{in} \pm (\dot{s}_{in} + \dot{\delta}_{in}) \right] \quad (18)$$

The stated approach allows to build valve gear mathematical models in the view of oil hydrodynamics in its gaps. The number and parameters of these gaps are set in the initial data. The Eqs. (1) or (10) after downturn of

the order by introduction of additional variables in a combination with Eqs. (16) or (17) also is solved numerically by Runge-Kutta method.

The submitted model allows to build valve gear calculation schemes with the desirable structure. Thus the number of elements in each of branches can vary. It allows to simplify the definition of some dynamic model parameters as the concrete model can be constructed so that parameters of its parts coincide with the parameters of corresponding details. In this case the necessity of precomputation of resulted weights and stiffness of the elements disappears.

The multimass calculation schemes constructed on the basis of considered generalized model, allow to specify dynamic loadings in separate valve gear parts and to locate interfaces in which there is a break of a kinematic link. Besides there is an opportunity of calculation of shock forces at contacts restoration, in particular, definitions of impact force between the pusher and cam, the valve and seat.

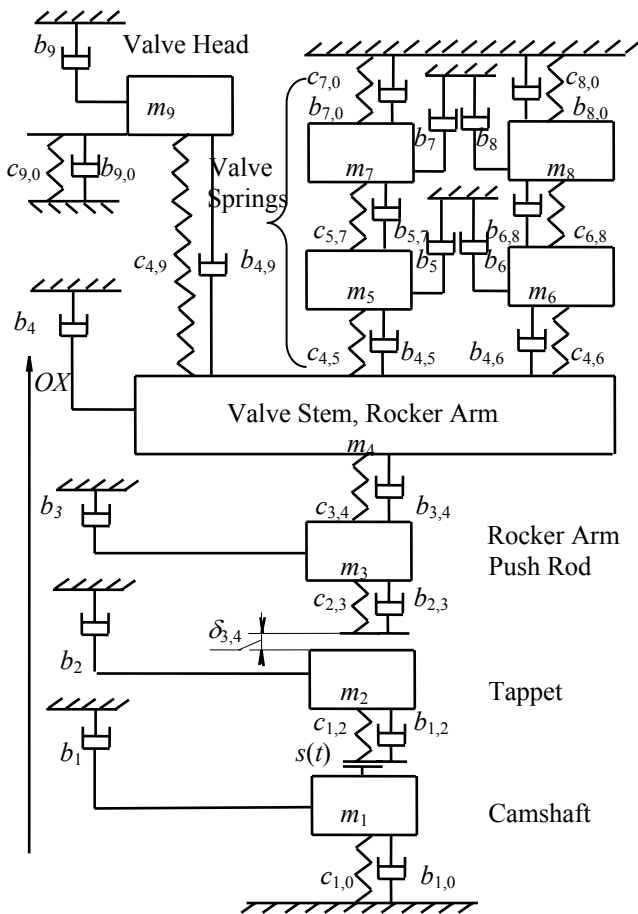

Fig. 1 Calculation scheme for valve gear dynamics investigation with the lower camshaft disposition and two valve springs

The use of multimass schemes also is necessary, for example, for a drive moving several valves from one cam. Thus, the submitted generalized mathematical model of valve gear dynamics allows to make modeling with a high degree of adequacy to real mechanisms on the basis of more correct representation of physical processes occurring in the valve gear.

The opportunity of oil hydrodynamics calculation

in the model also is provided at the presence of bearing hydrodynamical force in the cam-tappet link. Calculation of oil film thickness between the cam and the tappet can be executed on the basis of the elastohydrodynamical theory [3]. However corresponding formula is received for the steady regime and takes into account the speed of oil involving into the contact zone, the growth of oil viscosity with pressure increase and also the deformation of loading surfaces. In our case the process is unsteady as the effort in contact, radius of profile curvature and hydrodynamic effective speed change during cam rotation.

Therefore, the above mentioned formula allows to find only quasi-steady value of the oil film thickness depending on cam rotation angle. In some cases such calculation gives inaccurate results. So, if in some point of the cam profile hydrodynamic effective speed becomes zero, the lubricant film should become torn. However in practice it is not observed [4, 5] as for a short time interval the film thickness has not time to decrease up to zero owing to oil film replacement effect.

Relating to this in a number of works the effect of oil replacement is taken into account. It allows to calculate more exactly the oil film thickness, to define lubrication regime and to estimate wear process characteristics. This effect becomes dominating at zero value of the hydrodynamic effective speed.

In [4, 5] there is the formula relating bearing force of the replaced oil with oil film thickness and with the speed of surfaces rapprochement. This formula is specified in [6] and gives the satisfactory coordination of the calculation with experimental data. With the same purpose Eq. (16) can be used at the definition of factor  $K_{in}$  for our case of the deformed surfaces contact [7].

During rapprochement of the contacting surfaces (or reduction of the oil film thickness) external loading  $Q$  is equal to the algebraic sum of bearing force of superseded oil  $Q_B$  and bearing hydrodynamical force  $Q_H$  arising due the contact point movement on working surfaces of the cam and the tappet

$$Q = Q_B + Q_H \quad (19)$$

If the oil film thickness increases its calculation can be executed by the technique [3], assuming  $Q = Q_H$ , as bearing force of the oil replacement  $Q_B$  is equal to zero.

On the basis of the stated technique the algorithm of step-by-step iterative calculation of non stationary oil film thickness value in a cam - tappet pair is developed. Thus the force the valve gear mathematical model is used as external loading  $Q$ . In this case oscillatory processes in the valve gear are taken into account, and the calculation is more exact.

Besides the simulation of hydraulic tappets is realized. The law of plunger movement is determined from the solution of the corresponding differential equation taking into account both pressure component (caused by pressure in the compression chamber), and viscous component, resulting from viscous damping on the moving plate [8].

During plunger movement from hydraulic tappet body (plunger velocity  $\dot{x}_p > 0$ )

$$f = p_m s_p - 2\pi R_p L \eta \dot{x}_p / h \quad (20)$$

where  $p_m$  is oil pressure;  $s_p$  is area of bottom surface of

tappet plunger;  $R_p$  is radius of tappet plunger;  $L$  is length of oil leakage path in the tappet;  $\eta$  is dynamic oil viscosity;  $h$  is radial clearance of leakage path in the tappet.

If  $\dot{x}_p < 0$

$$f = -2\pi R_p L \eta \dot{x}_p (3R_p^2 + 4h^2 + 6R_p h) / h^3 \quad (21)$$

Sometimes in compression chamber a compressed spring is additionally installed. In this case the value of force  $f$ , calculated from (20) or (21), is necessary to increase by  $[f_0 - c_p(x_p - x_{p0})]$ , where  $f_0$  and  $c_p$  are accordingly initial effort and stiffness of the spring.

For the definition of plunger movement law it is necessary to solve the differential equation

$$m_p \ddot{x}_p = f - f_k \quad (22)$$

where  $\ddot{x}$  is plunger acceleration,  $m_p$  is its mass,  $f_k$  is force, acting on the plunger from valve gear at oscillatory processes. At the presence of hydraulic tappet in the valve gear ( $s + x_p$ ) and ( $\dot{s} + \dot{x}_p$ ) in Eqs. (4) - (7), (15), (17), (18) are used instead of  $s_{in}$  and  $\dot{s}_{in}$  accordingly.

### 3. Discussion

The calculation scheme, shown in Fig. 1, was used for valve gear dynamics research of the engine 8ЧВН15/16, made at the Volgograd motor plant. In Fig. 2 some of the received calculation diagrams are presented. The estimation of adequacy of dynamical model was carried out with the use of Fisher criterion by comparison, in particular, experimental and calculation values of the maximal and minimal peak forces in the valve gear during oscillations. The analysis of comparison results allows to draw a conclusion on good conformity of experiment and calculations.

In Fig. 3 the results of oil film thickness calculation in the a cam - tappet pair are shown. The curve 1 is received at quasi-steady calculation [3] when loading interfaces by valve springs forces and inertia forces. The curve 2 corresponds to the calculation taking into account oil replacement effect by the technique stated above (unsteady calculation) and the same, as well as for a curve 1, cam-tappet pair loading. At last, the curve 3 is received accounting unsteady oil hydrodynamics and the presence of oscillatory processes in the mechanism, modeled on the basis of the generalized mathematical model given above. Calculation is executed for rotation frequency of a crankshaft 1700 rev/min and a zero heat clearance.

Curves 1 and 2 differ due to the presence of oil replacement effect. Differences are especially appreciable in the field of the minimal thickness and become more essential with the growth of cam rotation frequency, and also at discontinuous tappet acceleration.

Obvious influence on the accuracy of force calculation has the evaluation of oscillatory processes in the mechanism. Distinctions of curves 2 and 3 are the greatest in operative ranges of oil replacement effects and are insignificant when the later do not occur. Loading change has a poor influence on oil film thickness due to a small exponent at the loading, equal (-0.13). The increase of oil

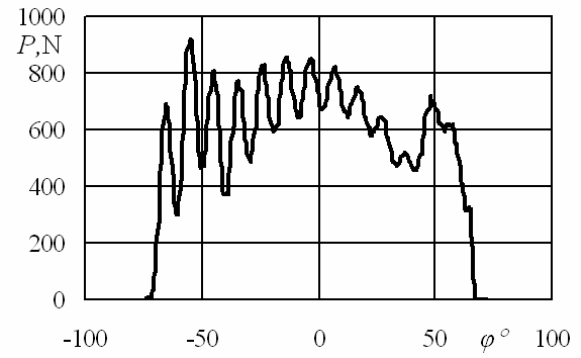

a

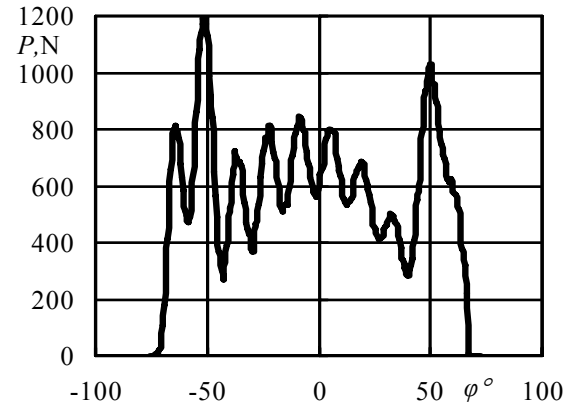

b

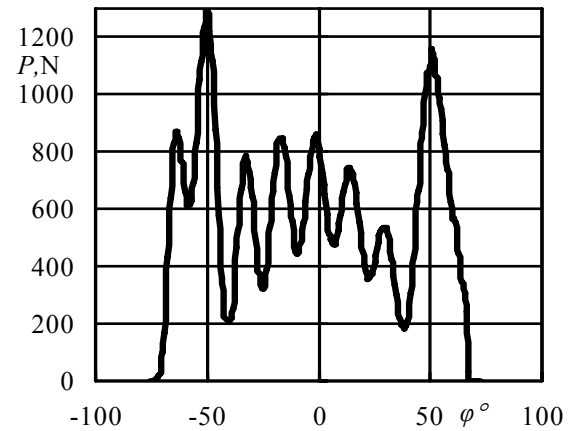

c

Fig. 2 Force in valve gear rocker arm versus cam rotation angle at heat clearance 0.1 mm: a - 1250 rpm; b - 1700 rpm; c - 1900 rpm

film thickness at the beginning and end of valve movement (can be observed in curve 3 in comparison with curves 1 and 2) is caused by gradual cam-tappet pair loading and unloading (the effect is included into the mathematical model).

Thus, the developed generalized mathematical model of valve gear dynamics, allowing to calculate oil hydrodynamics in its interfaces, provides more exact definition of the valve gear dynamical and tribological characteristics being a basis for an estimation of its serviceability and reliability.

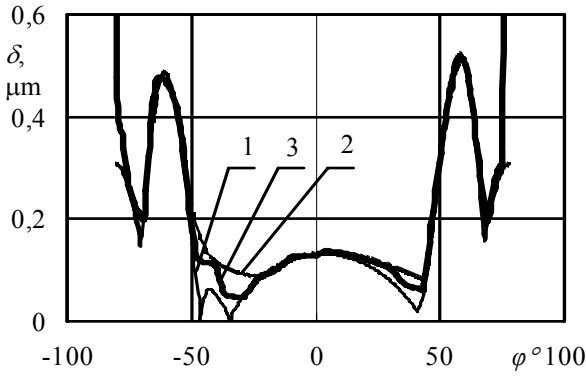

Fig. 3 Cam-tappet oil film thickness versus cam rotation angle: 1 - quasi-steady regime; 2 - unsteady regime; 3 - unsteady regime with valve gear oscillatory processes

Using the developed technique a valve gear with hydraulic tappet also has been investigated. As initial the nine-mass dynamical model (Fig. 1), identified using experimental data, was accepted. Parameters of the used hydraulic tappet:  $L = 14$  mm,  $R_p = 7$  mm,  $h = 0.025$  mm,  $p_m = -0.4$  MPa,  $m_p = 0.02$  kg,  $\eta = 0.012$  H $\times$ c/m<sup>2</sup>.

Curves 1 and 2 on Fig. 4 correspond to rotation frequency of the engine crankshaft  $n=1700$  rev/min and to initial heat clearance in the valve gear – 0.3 mm. From the presented data follows, that the plunger of hydraulic tappet is put forward from the case with high speed in an initial phase of movement. This speed even exceeds the speed of tappet body controlled by the cam. When compressing force occurs in the valve gear (when summary displacement of the plunger and tappet body becomes equal to the initial value of heat clearance) the plunger starts to move to the opposite side. After the valve reaches the seat ( $\varphi = 62^\circ$ ) plunger speed relative to tappet body is a little bit lower than at the beginning of its movement as it is limited to divergence speed of the tappet body and the detail of valve gear connected to it. Because of high speed of established initial heat clearance compensation all further calculations were carried out at zero value assumption of the latter, because it is quickly compensated if arises in result of power setting change.

Curves 1, 2, 3 and 4 on Fig. 5 correspond to engine crankshaft rotation frequencies accordingly 1000, 1250, 1700, 1900 rev/min. The maximal plunger displacements depending on high-speed mode are shown in Fig. 6. From the presented diagrams follows, that high-speed operating mode has essential influence on plunger movement, reducing valve displacement and causing to its earlier return. So, at  $n = 1000$  rev/min the maximal relative plunger displacement at the end of valve movement is 517  $\mu$ m, and at  $n = 1900$  rev/min - 277  $\mu$ m. On one hand, it changes the average valve rise and its time-section, on the other hand - leads to valve timing change. From data in Fig. 7 follows, that at  $n = 1000$  rev/min the valve sits down on the seat at  $\varphi = 58.7^\circ$ , at  $n = 1900$  rev/min the valve landing angle is  $\varphi = 63.2^\circ$ , and there is no hydraulic tappet and zero heat clearance  $\varphi = 70.7^\circ$  (in view of valve gear deformation).

Analyzing the received results it is necessary to take into account the following circumstances.

1. When hydraulic tappet is used in all cases the

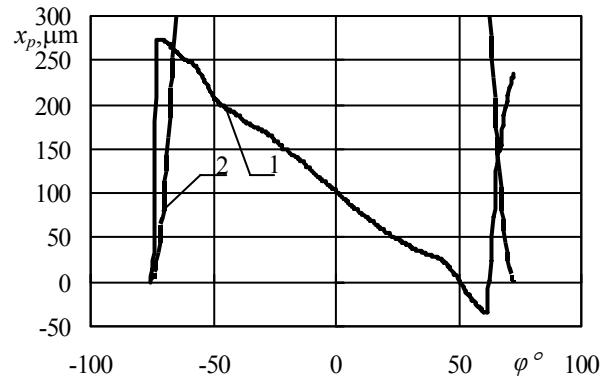

Fig. 4 Plunger displacement according hydraulic tappet body (1) and hydraulic tappet body displacement (2) versus cam rotation angle

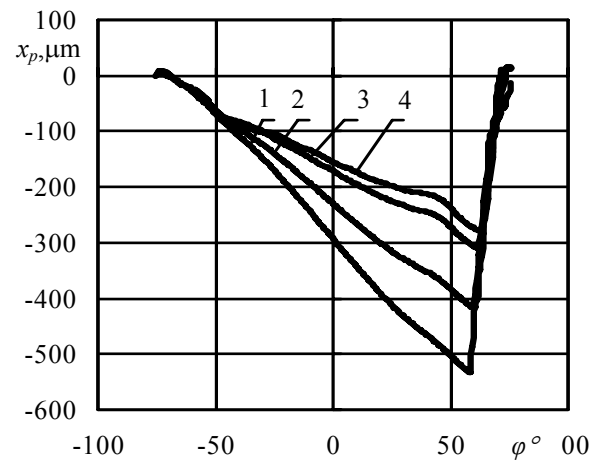

Fig. 5 Plunger displacement according hydraulic tappet body versus cam rotation angle: 1 - 1000 rpm; 2 - 1250 rpm; 3 - 1700 rpm; 4 - 1900 rpm

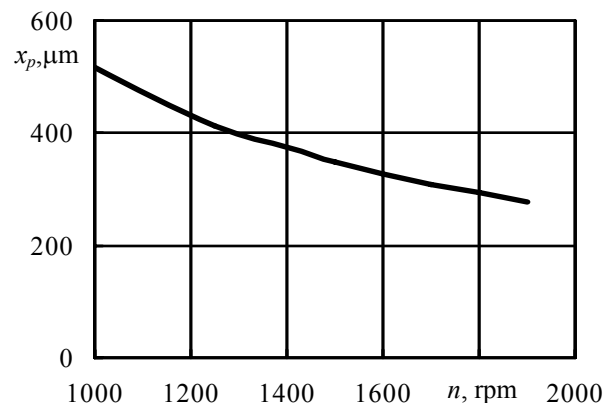

Fig. 6 Maximum plunger displacement concerning hydraulic tappet body versus crankshaft speed

phase of the valve landing is shifted, and the phase of its opening remains to constant irrespective of thermal power setting.

2. It is known, that for optimal gas exchange at camshaft velocity increase it is necessary to increase valve timings and angular extent of the valve action. In this case the application of the hydraulic tappet can be reasonable.

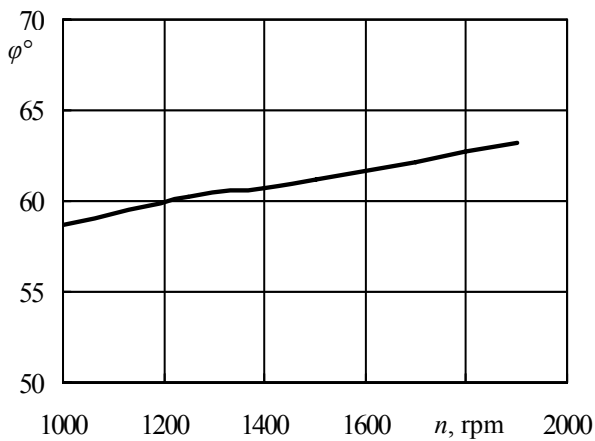

Fig. 7 Cam rotation angle corresponding to valve landing on its seat in valve gear with hydraulic tappet versus crankshaft speed

3. Valve gear heat clearance is not stable when there is no hydraulic tappet. It is experimentally established, that in the exhaust valve gear of the engine 8ЧBH15/16 it changes depending on operating mode in the range 0 - 0.66 mm at the valve side. Thus, phases of the beginning, and the end of the valve movement are shifted, and the law of timings expansion with the growth of rotation frequency can not be observed. Already at the clearance of 0.6 mm valve landing angle decreases up to 58° at corresponding alteration of the rise beginning phase. So it is possible to draw a conclusion that the application of hydraulic tappet can promote an improvement not only of valve gear dynamics, but gas exchange, and engine parameters at various modes as well.

4. Maximal plunger displacement under the action of compressing force in a valve gear and, the change of timings, can be reduced by corresponding choice of the sizes. The performed calculations have shown, that due to radial clearance  $h$  reduction between the case and plunger from 0.025 mm to 0.02 mm the maximal relative plunger displacement was reduced from 308  $\mu\text{m}$  up to 161  $\mu\text{m}$ .

The influence of the hydraulic tappet on valve gear dynamics is important. Executed calculations allow to draw a conclusion about appreciable reduction of the oscillation intensity with the hydraulic tappet. Mean square deviation of acting force in oscillatory process from its quasi-stationary values (without taking into account oscillations) were 139 N at the presence of hydraulic tappet, and at 178 N without it. This phenomenon can be explained by energy dissipation during oil replacement.

At last, the developed mathematical model allows to estimate the influence of hydraulic tappet on valve time-section. For the researched engine 8ЧBH15/16 this influence can be appreciated as insignificant. So, on a nominal operating mode at the chosen dimensions of hydraulic tappet the reduction of time-section was about 1.5%, that is approximately twice less, than its reduction at the increase in heat clearance from 0 up to 0.3 mm without the hydraulic tappet.

Thus, the developed generalized valve gear dynamics mathematical model allows to investigate the influence of hydraulic tappet on valve timings, valve time - section, valve gear dynamics on various engine operation regimes, and also to optimize hydraulic tappet parameters.

The use of hydraulic tappet in the valve gear of the engine 8ЧBH15/16 promotes the reduction of undesirable valve timings change in a range of operational regimes.

#### 4. Conclusions

Generalized mathematical model of internal combustion engine valve gear is developed. In the given model the concrete calculation scheme of the internal combustion engine valve gear can be constructed in an automated procedure without limitations on its structure and quantity of masses. It allows to build the calculation schemes of required structure and complexity according to valve gear type, taking into consideration valve gear design features, such as presence of initial forces or clearances in links, variability of parameters, energy dissipation at oscillations, possibility of kinematic chain breaks in one-way links and impact interaction of details. Besides the simulation of oil hydrodynamics both in the gaps and hydraulic tappets is also provided. Calculation results of valve gear oscillatory processes, confirming the model adequacy at various engine operation regimes, are given.

The developed generalized valve gear dynamics mathematical model allows to investigate the influence of hydraulic tappet on valve timings, valve time - section, valve gear dynamics on various engine operation regimes, and also to optimize hydraulic tappet parameters. The use of hydraulic tappet in the valve gear of the engine 8ЧBH15/16 promotes the reduction of undesirable valve timings change in a range of operational regimes.

#### References

1. **Korchemy, L.V.** Valve gear of the automotive engine: Kinematics and dynamics.-Second edition.- Moscow: Mechanical engineering, 1981.-191p.
2. **Kosugi, T., Seino, T.** Valve motion simulation method for high-speed internal combustion engines. -SAE Techn. Pap. Ser., 1985, No.850179, p.1-10.
3. **Dowson, D., Higginson, G.R.** Elastohydrodynamic Lubrication. -London: Pergamon Press, 1966. -235p.
4. **Holland, J.** Die instationäre Elastohydrodynamik. - Konstruktion, 1978, v.30, h.9, s.363-369.
5. **Holland J.** Zur Ausbildung eines Tragfähigen Schmierfilms zwischen Nocken und Stoßel. -MTZ, 1978, v.39, No.5, s.225-231.
6. **Holland J., Ruhr W.** Auslegung und Optimierung von Nockentrieben hinsichtlich des Verschleißverhaltens. - MTZ, 1986, v.47, No.1, s.37-43.
7. **Kreuter, P., Pischinger, F.** Valve train calculation model with regard to oil film effects. -SAE Techn. Pap. Ser, 1985, No.850399, p.1-10.
8. **Chan, C., Pisano, A.P.** Dynamic model of a fluctuating rocker-arm ratio cam system. -Trans. of the ASME: J. of Mechanisms, Transmissions, and Automation in Design, 1987, v.109, No.3, p.356-365.

A. Vasilyev

VOŽTUVŲ MECHANIZMO DINAMIKOS  
MODELIAVIMAS, TAIKANT APIBENDRINTĄ  
DINAMINĮ MODELĮ

Re z i u m ė

Straipsnyje pateiktas vidaus degimo variklio vožtuvų mechanizmo apibendrintas dinaminis modelis. Modelis leidžia sudaryti reikiamos struktūros ir sudėtingumo automatinio režimo skaičiavimo schemas, atsižvelgiant į vožtuvų mechanizmo ypatumus, tokius kaip pradinės įvaržos ir tarpai jungtyse, kai kurių parametrų kitimas, energijos sklaida virpant, vienpusių jungčių suirimo ir detalių smūginės sąveikos galimybės. Taip pat numatytas mechanizmo tarpų ir hidraulinių elementų tepimo hidrodinamikos modeliavimas. Pateikti virpesių proceso skaičiavimo rezultatai patvirtina modelio adekvatumą varikliui dirbant įvairiais režimais. Pateikti hidraulinio stūmiklio skaičiavimai leidžia įvertinti jo įtaką dujų paskirstymo fazei ir mechanizmo virpesių procesui esant įvairiems darbinio greičio režimams.

A. Vasilyev

SIMULATION OF VALVE GEAR DYNAMICS USING  
GENERALIZED DYNAMIC MODEL

S u m m a r y

The paper presents a generalized dynamic model of valve gear of internal combustion engine. This model allows to build calculation schemes of required structure and complexity in an automated procedure, taking into consideration valve gear design features, such as presence of initial forces or clearances in links, variability of parameters, energy dissipation at oscillations, possibility of kinematic chain breaks in one-way links and impact inter-

action of details. The simulation of oil hydrodynamics both in the gaps and hydraulic tappets is also provided.

Calculation results of valve gear oscillatory processes, confirming the model adequacy at various engine operation regimes, are given. The presented calculations of hydraulic tappet allow to estimate its influence on valve timing and oscillatory processes in the mechanism at various high-speed power setting.

А. Васильев

МОДЕЛИРОВАНИЕ ДИНАМИКИ КЛАПАННОГО  
МЕХАНИЗМА С ИСПОЛЬЗОВАНИЕМ  
ОБОБЩЕННОЙ ДИНАМИЧЕСКОЙ МОДЕЛИ

Р е з ю м е

В статье представлена обобщённая динамическая модель клапанного механизма двигателя внутреннего сгорания. Эта модель позволяет строить расчётные схемы требуемой структуры и сложности в автоматическом режиме с учётом особенностей клапанного механизма, таких, как наличие начальных усилий и зазоров в связях, переменности некоторых параметров, рассеяния энергии при колебаниях, возможности разрыва кинематической цепи в односторонних связях и ударного взаимодействия деталей. Предусмотрено также моделирование гидродинамики смазки в зазорах и гидравлических элементах механизма.

Приведены результаты расчёта колебательных процессов в клапанном механизме, подтверждающие адекватность модели на различных режимах работы двигателя. Представленные расчёты гидротолкателя позволяют оценивать его влияние на фазы газораспределения и колебательный процесс в механизме на разных скоростных режимах работы.

Received October 12, 2005